

Data Sheet



Article number: 2307033211

Description: E+G Two-spoke handwheel
VRTP.200-GXX2-A16

Measures

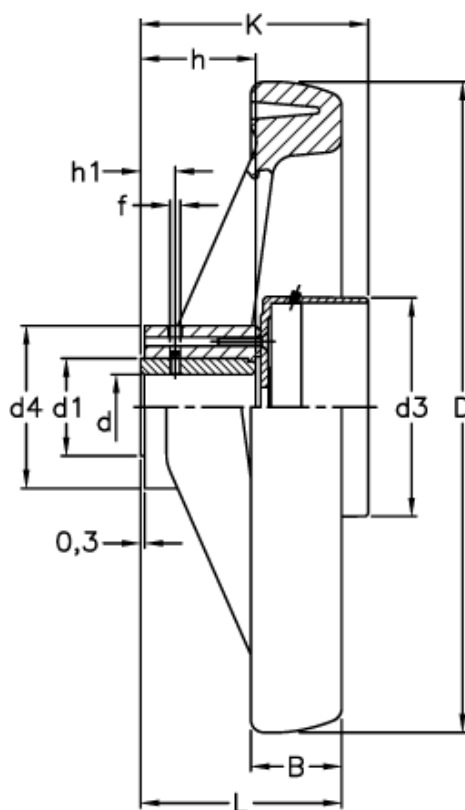

B	= 28	h1	= 12
D	= 200	K	= 70
d1	= 30	L	= 61
d3	= 76		
d4	= 50		
d H7	= 16		
f	= M8		
h	= 34		